



varia G inverse

Der niedrige Allrounder

Le modèle bas polyvalent | The low-level allrounder



Im Grossen denken -
im Kleinsten präzisieren.

varia G inverse

NEW

Der niedrige Allrounder für Ihre zentrisch zu spannenden Werkstücken. Inkl. Backenschnellwechselsystem, welches ein Wechseln werkzeuglos zulässt.

Le tout-en-un compact pour vos pièces à serrer de manière centrée. Inclus un système de changement rapide des mors, permettant un échange sans outil.

The compact all-rounder for your centric clamping workpieces. Includes a quick-jaw-change system that allows tool-free switching.

BOHRUNG SEITENANSCHLAG

Seitenanschlag geschraubt oder magnetisch montierbar.

ALÉSAGE BUTÉE LATÉRALE

Butée latérale vissée ou montage magnétique.

BOREHOLE, LATERAL STOP

Lateral stop screwed or can be mounted magnetically.

ABDECKUNG

Zum Schutz der Spanneinsatztaschen.

CACHE

Pour protéger les poches d'inserts de serrage.

COVER

To protect the clampinginsert pockets.

GRUNDPLATTE

Die Bauweise garantiert höchste Steifigkeit ohne Verformung der Grundplatte. Es stehen diverse Standard-Adapterbohrbilder zur Auswahl. Kompatibel zu speed.change 30, EROWA und Quickpoint 96.

PLAQUE DE BASE

La structure garantit une extrême rigidité sans déformation de la plaque de base.

BASE PLATE

The design ensures maximum rigidity without deforming the base plate. There are various standard adapter drilling patterns to choose from. Compatible with speed.change 30, EROWA and Quickpoint 96.

AUFSATZBACKENGEOMETRIE

Beste Zugänglichkeit durch optimierte Aufsatzbackengeometrie.

GÉOMÉTRIE DES MORS RAPPORTÉS

Accès idéal grâce à la géométrie optimisée des mors rapportés.

TOP JAW GEOMETRY

Best accessibility thanks to optimized top jaw geometry.

SPANNEINSÄTZE

Mit den hemo Grip Spanneinsätzen ist kein Vorprägen nötig. Weitere Spanngeometrien erhältlich.

GÉOMÉTRIE DE SERRAGE

Grâce à la géométrie de serrage du système hemo Grip, pas besoin de pré-gaufrage. Autres géométries de serrage disponibles.

CLAMPING GEOMETRY

Pre-stamping is not necessary with the hemo Grip clamping geometry. Other clamping geometries available.

AUFSATZBACKEN

Diese sind werkzeuglos wendbar. Innert Sekunden kann die Spannweite verändert werden.

MÂCHOIRES SUPÉRIEURES

Ceux-ci peuvent être tournés sans outils. La durée peut être modifiée en quelques secondes.

TOP JAWS

These can be turned without tools. The span can be changed within seconds.

SPINDEL

Obenliegende Spindel für höchste Haltekräfte. Freiliegend, dadurch schmutzunempfindlich.

BROCHE

Broche en hauteur pour forces de maintien maximales. Non encastrée et donc insensible à la saleté.

SPINDLE

Top-lying spindle for maximum holding forces. Exposed, and therefore dirt resistant.



Vorteile:

- Beste Zugänglichkeit
- Höchste Haltekräfte
- Schmutzunempfindlich, allseitig freier Spänefluss
- Austauschbare und Mehrfachverwendbare Spanneinsätze mit verschiedenen Konturen
- Adapterbohrungen im Standard auf speed.change 30 und weitere Nullpunktspann- und Palettiersysteme
- Für die Roh- und Fertigteilspannung bestens geeignet
- Austausch- und wendbare Aufsatzbacken

Avantages:

- Meilleure accessibilité
- Forces de serrage les plus élevées
- Résistant à la saleté sur tous les côtés écoulement de copeaux libre
- Inserts de serrage remplaçables et réutilisables avec différents contours
- Trous d'adaptateur standard sur la vitesse hemo.change 30 et autres systèmes de serrage et de palettisation à point zéro
- Idéal pour les pièces brutes et finies
- Mâchoires de serrage interchangeables et réversibles

Advantages:

- Best accessibility
- Highest clamping forces
- Resistant to dirt on all sides free chip flow
- Replaceable and reusable clamping inserts with different contours
- Standard adapter holes on speed.change 30 and other zero point clamping and palletizing systems
- Ideal for raw and finished parts
- Interchangeable and reversible clamping jaws

Modularer Aufbau | Construction modulaire | Modular design

Spanneinsätze
Inserts de serrage
Clamping inserts



Seite | Page | Page 13

Aufsatzbacken und Zubehör

Mors de base et accessoires

Base jaws and accessories



Seite | Page | Page 15

Spannmittel varia G inverse

Etau à serrage varia Plus

Vice varia Plus



Seite | Page | Page 7

Zubehör für Montage auf Maschinentisch

Accessoires pour la montage sur table de machine

Accessories for mounting on machine table



(Katalog) Seite | Page | Page 116

Maschinentisch

Table de machine

Machine table

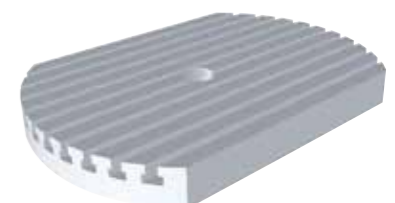



Konfigurieren Sie Ihren eigenen varia Polytec in nur vier Schritten
 Configurez votre propre varia Polytec en quatre étapes
 Configure your own varia Polytec in just four steps

1 Wahl der Aufsatzbacken
 Choix de mors de mâchoires
 Exchangeable jaw selection

		Breite Largeur Width
Für Spanneinsätze pour inserts de serrage / for clamping inserts		78 mm
	Z 78WS  Seite Page Page 15	
		114 mm
	Z 114WS  Seite Page Page 15	
Stufen geschliffen Meulage par ét. / Step Ground Mach.		114 mm
	Z 114WY1  Seite Page Page 15	
Bearbeitbar Usinables / Machinable		114 mm
	Z 114WB Seite Page Page 15	

2 Wahl der Grundplatte
 Choix de plaque de base
 Base pick selection

Spannbereich (Grundplatte) Plage de serrage (Plaque de base) Clamping range (Base plate)	
	6 - 170 mm (210 mm)
 Seite Page Page 7	

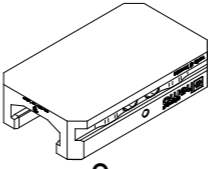
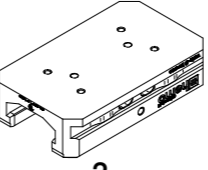
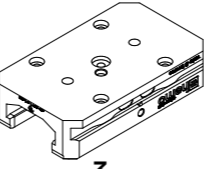
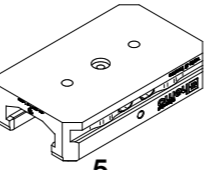
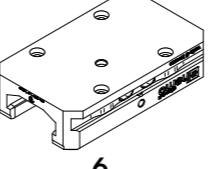
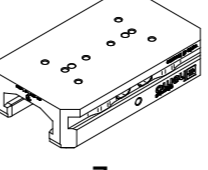

3 Wahl der Adapterbohrung
 Choix de alésage d'adaptation
 Choise of adapter boreholes

Adapterbohrung Alésages d'adaptation Adapter boreholes	
	ohne sans without
	kundenspezifisch spécifique au client customer-specific
	speed.change 30 EROWA VPC 96 Quick-Point 96
	speed.change 30
	EROWA VPC 96 Quick-Point 96
	EROWA ITS P ER-115521 EROWA ITS G ER-115308 EROWA MTS ER-129663

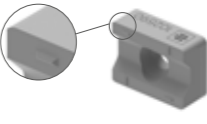
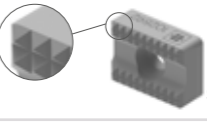
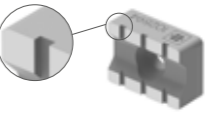
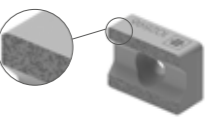
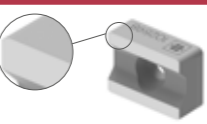
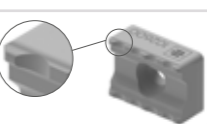

Hier gehts zur
Lochbildvermessung vom
varia G inverse

4 Wahl des Spanneinsatzes
 Choix de insert de serrage
 Clamping selection

Typ Type Type	
	hemo Grip hemo Grip hemo Grip
	spitz geriffelt rainurage pointu pointed corrugation
	flach geriffelt rainurage plat flat corrugation
	flach, Hartmetall beschichtet plane, peinture de métal dur flat, hard metal coated
	flach plane flat
	für Prägesysteme pur le système de gaufrage for pres clamping system
 Seite Page Page 13	

Bestellbeispiel
Exemple de commande
Order example
Z114WB-210GN-6



Bestellbeispiel
Exemple de commande
Order example
Z78WS-210GN-2-fh



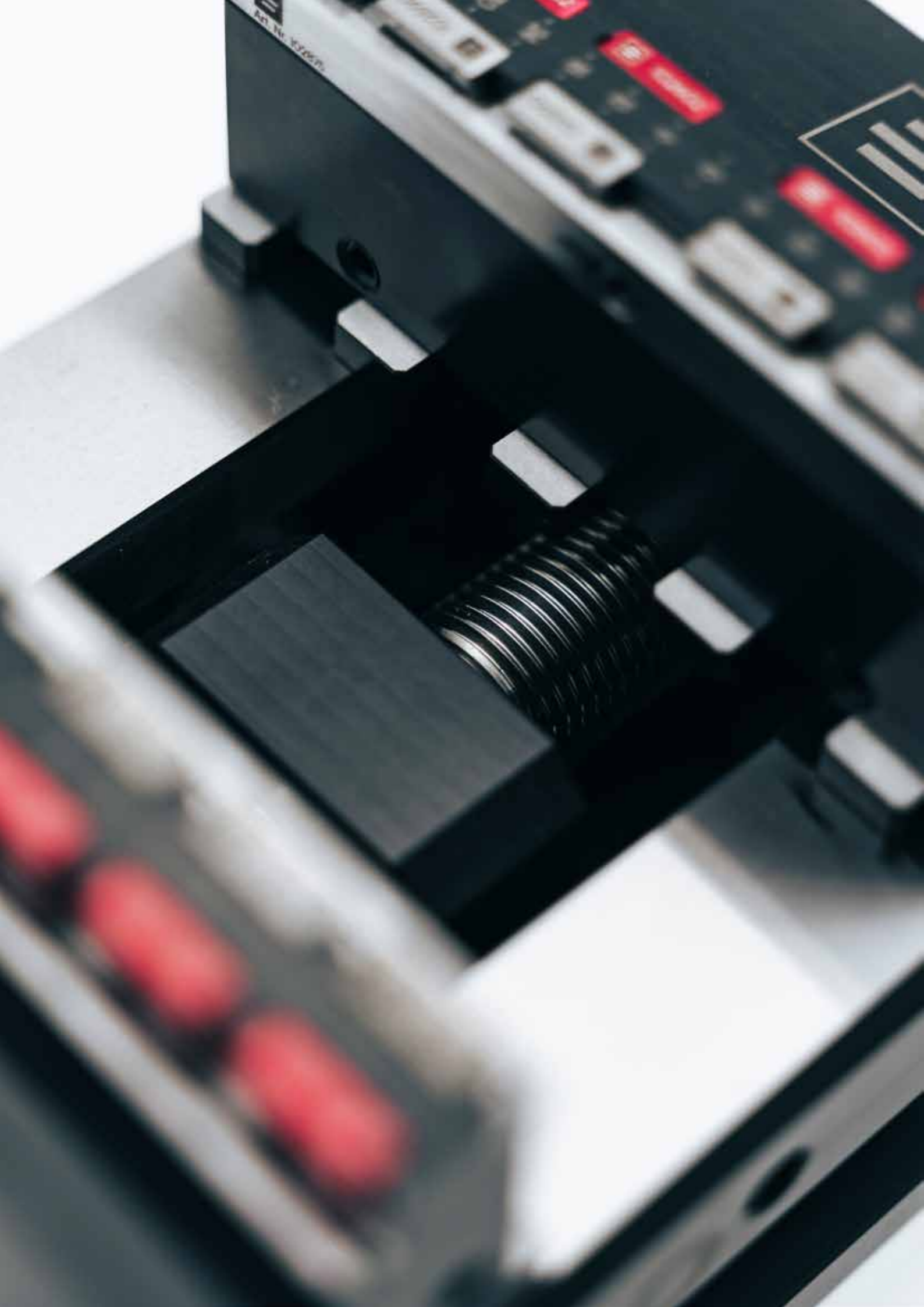

varia G inverse

varia G inverse	A ¹	A ²	A ³	B ¹	B ²	C ¹	C ²	D ¹	D ²	D ³	D ⁴	D ⁵	E ¹
Z78WS-210GN-_-_-	125	114	78	6-90	86-170	210	224	51	56	82.5	91	94	10
Z114WS-210GN-_-_-	125	114	114	6-90	86-170	210	224	51	56	82.5	91	94	10

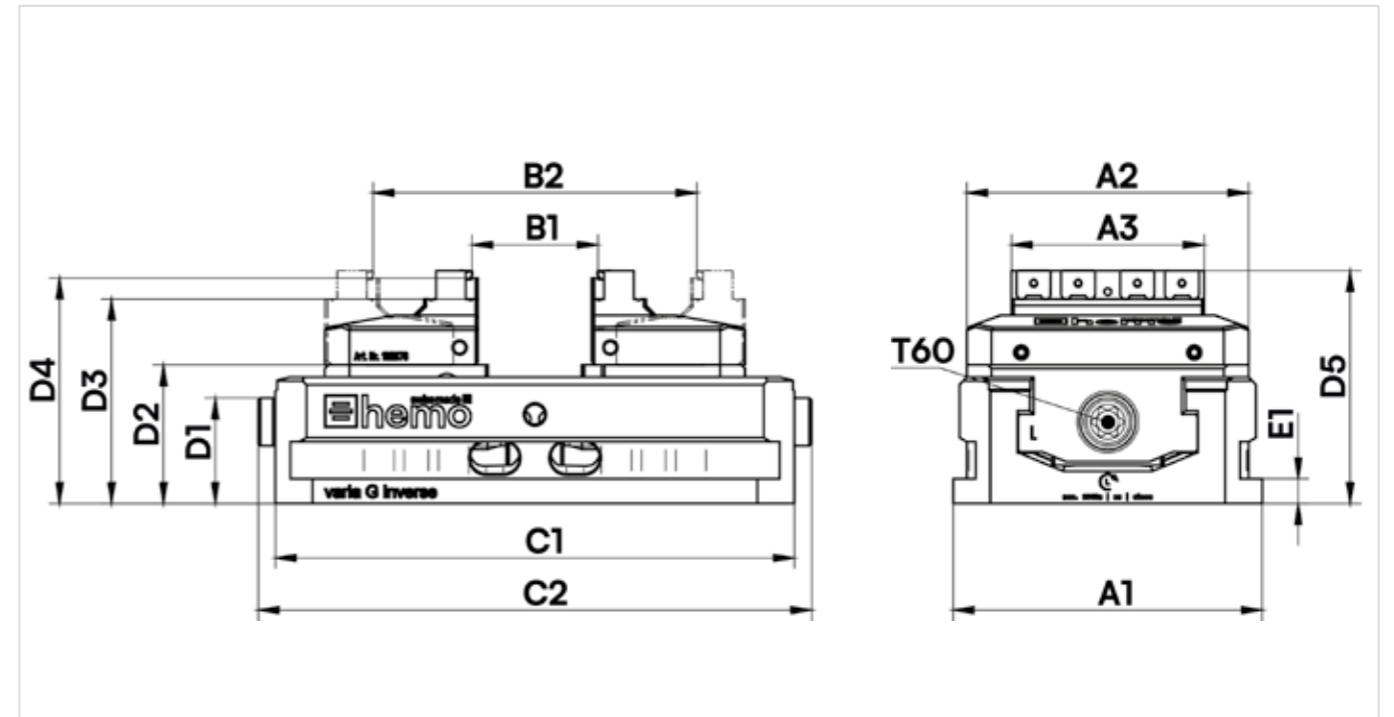

Technische Informationen | Information techniques | Technical information

Max. Spannkraft (kN) Force de serrage max. (kN) Max. Clamp Force (kN)	Max. Anzugs-Drehmoment (Nm) Couple max. (Nm) Max. Torque (Nm)	Wiederholgenauigkeit (mm) Répétabilité (mm) Repeatability (mm)
50	100	≤ 0.01

Spannkraftdiagramm | Diagramme de tension-force | Clamping force diagram

Gemessen am Werkstück in Produktionsumgebung mit Kühlschmierstoffemulsion. DIN 6386: Die Spannkraft ist die Summe aller auf das Werkstück wirkenden Backenkräfte.

Mesurée sur la pièce dans un environnement de production avec émulsion de lubrifiant réfrigérant. DIN 6386: La force de serrage est la somme de toutes les forces des mâchoires agissant sur la pièce d'usinage.

Measured on the workpiece in production environment with cooling lubricant emulsion. DIN 6386: The clamping force is the sum of all jaw forces impacting on the workpiece.

Spannkraft (kN) | Force de serrage (kN) | Clamping Force (kN)

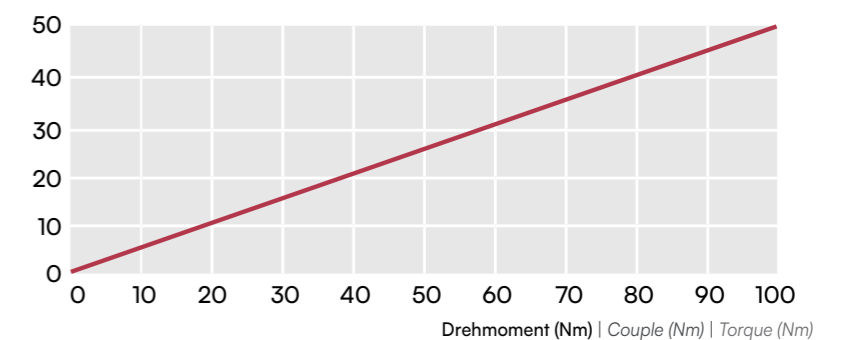

varia G inverse

Bezeichnung Description Description	Artikelnr. Nr.d'article Article No.	Spannbereich Cap. de serrage Clamping range	Spannkraft Force de serrage Clamp Force	Spannhub C. de serrage Cl. stroke	Gewicht Poids Weight	Masse (mm) Dimensions (mm) Dimensions (mm)											Lieferumfang Éléments livrés Scope of Delivery					
						A ¹	A ²	A ³	B ¹	B ²	C ¹	C ²	D ¹	D ²	D ³	D ⁴		D ⁵	E ¹			
 varia G inverse																						
Z78WS-210GN																						
	ohne Adapterbohrungen (0) sans perçages d'adaptation(0) without adapter boreholes (0)	102942															1x Grundplatte mit Spindel 2x Grundbacken 2x 102879 Aufsatzbacke Z78WS 8x Spanneinsätze (nach Ihrer Wahl, s. S. 13) 2x 102604 Werkstückauflage 10x 102609 Schrauben M3.5 1x 102619 Fähnchenschlüssel					
	Adapterbohrungen 2 perçages d'adaptation 2 adapter boreholes 2	102943															1x Base avec broche 2x Mâchoires de base 2x 102879 Mâchoire supérieure Z78WS 8x Inserts de serrage (à votre choix, v. p. 13) 2x 102604 Appui de pièce 10x 102609 Vis M3.5 1x 102619 Clé à fanion					
	Adapterbohrungen 3 perçages d'adaptation 3 adapter boreholes 3	Z78WS-210GN-3-__																1x Base plate with spindle 2x Base jaws 2x 102879 Top jaw Z78WS 8x Clamping inserts (of your choice, s.p. 13) 2x 102604 Workpiece support 10x 102609 Screws M3.5 1x 102619 Flag key				
	Adapterbohrungen 4 perçages d'adaptation 4 adapter boreholes 4	Z78WS-210GN-4-__																				
	Adapterbohrungen 5 perçages d'adaptation 5 adapter boreholes 5	102944																				
	Adapterbohrungen 6 perçages d'adaptation 6 adapter boreholes 6	102945																				
	Adapterbohrungen 7 perçages d'adaptation 7 adapter boreholes 7	102946																				
 varia G inverse																						
Z114WS-210GN																						
	ohne Adapterbohrungen (0) sans perçages d'adaptation(0) without adapter boreholes (0)	102915	6-170mm	50kN	84mm	12kg	125	114		6-90	86-170	210	224	51	56	82.5	91	94	10	1x Grundplatte mit Spindel 2x Grundbacken 2x 102873 Aufsatzbacke Z114WS 12x Spanneinsätze (nach Ihrer Wahl, siehe S. 13) 2x 102875 Werkstückauflage 14x 102609 Schrauben M3.5 1x 102619 Fähnchenschlüssel		
	Adapterbohrungen 2 perçages d'adaptation 2 adapter boreholes 2	102917																			1x Base avec broche 2x Mâchoires de base 2x 102873 Mâchoire supérieure Z114WS 12x Inserts de serrage (à votre choix, v. p. 13) 2x 102875 Appui de pièce 14x 102609 Vis M3.5 1x 102619 Clé à fanion	
	Adapterbohrungen 3 perçages d'adaptation 3 adapter boreholes 3	102916																				
	Adapterbohrungen 4 perçages d'adaptation 4 adapter boreholes 4	Z114WS-210GN-4-__																				1x Base plate with spindle 2x Base jaws 2x 102873 Top jaw Z114WS 12x Clamping inserts (of your choice, s. p. 13) 2x 102875 Workpiece support 14x 102609 Screws M3.5 1x 102619 Flag key
	Adapterbohrungen 5 perçages d'adaptation 5 adapter boreholes 5	102939																				
	Adapterbohrungen 6 perçages d'adaptation 6 adapter boreholes 6	102940																				
	Adapterbohrungen 7 perçages d'adaptation 7 adapter boreholes 7	102941																				





varia G inverse

Bezeichnung Description Description	Artikelnr. Nr.d'article Article No.	Spannbereich Cap. de serrage Clamp.range	Spannkraft Force de serrage Clamp Force	Spannhub C. de serrage Cl. stroke	Gewicht Poids Weight	Masse (mm) Dimensions (mm) Dimensions (mm)											Lieferumfang Eléments livrés Scope of Delivery			
						A ¹	A ²	A ³	B ¹	B ²	C ¹	C ²	D ¹	D ²	D ³	D ⁴		D ⁵	E ¹	
 varia G inverse Z114WY1-210GN																			1x Grundplatte mit Spindel 2x Grundbacken 2x 102906 Aufsatzbacke Z114WY1 1x Base avec broche 2x Mâchoires de base 2x 102906 Mâchoire supérieure Z114WY1 1x Base plate with spindle 2x Base jaws 2x 102906 Top jaw Z114WY1	
	ohne Adapterbohrungen (0) sans perçages d'adaptation(0) without adapter boreholes (0)	Z114WY1-210GN-0																		
	Adapterbohrungen 2 perçages d'adaptation 2 adapter boreholes 2	Z114WY1-210GN-2																		
	Adapterbohrungen 3 perçages d'adaptation 3 adapter boreholes 3	Z114WY1-210GN-3																		
	Adapterbohrungen 4 perçages d'adaptation 4 adapter boreholes 4	Z114WY1-210GN-4																		
	Adapterbohrungen 5 perçages d'adaptation 5 adapter boreholes 5	Z114WY1-210GN-5																		
	Adapterbohrungen 6 perçages d'adaptation 6 adapter boreholes 6	Z114WY1-210GN-6																		
	Adapterbohrungen 7 perçages d'adaptation 7 adapter boreholes 7	Z114WY1-210GN-7																		
 varia G inverse Z114WB-210GN			6-170mm	50kN	84mm	12kg	125	114	6-90	86-170	210	224	51	56	82.5	91	94	10	1x Grundplatte mit Spindel 2x Grundbacken 2x 102877 Aufsatzbacke Z114WB 1x Base avec broche 2x Mâchoires de base 2x 102877 Mâchoire supérieure Z114WB 1x Base plate with spindle 2x Base jaws 2x 102877 Top jaw Z114WB	
	Adapterbohrungen (0) perçages d'adaptation(0) adapter boreholes (0)	102947																		
	Adapterbohrungen 2 perçages d'adaptation 2 adapter boreholes 2	102948																		
	Adapterbohrungen 3 perçages d'adaptation 3 adapter boreholes 3	102969																		
	Adapterbohrungen 4 perçages d'adaptation 4 adapter boreholes 4	Z114WB-210GN-4																		
	Adapterbohrungen 5 perçages d'adaptation 5 adapter boreholes 5	102949																		
	Adapterbohrungen 6 perçages d'adaptation 6 adapter boreholes 6	102950																		
	Adapterbohrungen 7 perçages d'adaptation 7 adapter boreholes 7	102951																		

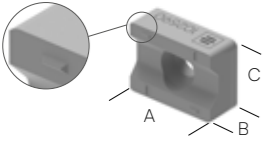
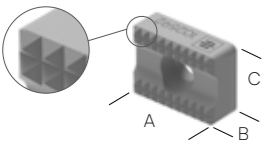
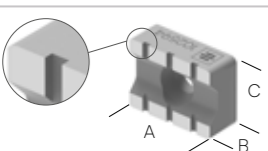
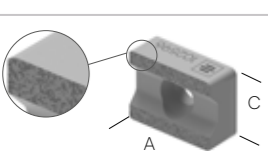
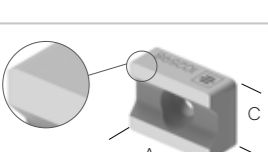
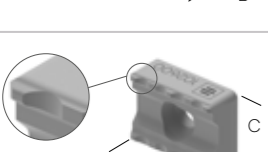

Spanneinsätze und weiteres Zubehör | Inserts de serrage et autres accessoires

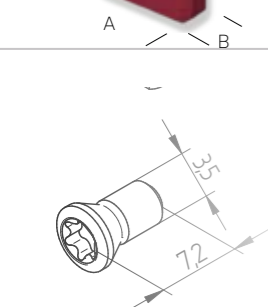
Clamping inserts and additional accessories



Bezeichnung Description Description	Artikelnr. Numéro d'article Article No.	Masse (mm) Dimensions (mm) Dimensions (mm)				Passend zu Backen compatible avec compatible with						Lieferumfang Éléments livrés Scope of Delivery	
		A	B	C	D	varia Plus			varia Polytec & G inverse				
						Z42S	Z78S	Z78B	Z 78WS	Z 114WS	Z 114WB		
 Spanneinsatz-gr hemo Grip Insert de serrage-gr hemo Grip clamping insert-gr hemo Grip	102590												1 Stk. Spanneinsatz (exkl. Schrauben)
	102891	14	5	10	-	●	●		●	●			6 Stk. Spanneinsätze (inkl. 2 Stk. 102609 Schrauben)
	102812												8 Stk. Spanneinsätze (inkl. 2 Stk. 102609 Schrauben)
	102591												10 Stk. Spanneinsätze (exkl. Schrauben)
 Spanneinsatz-sg spitz geriffelt Insert de serrage-sg à rainurage pointu clamping insert-sg pointed corrugation	102592												1 Stk. Spanneinsatz (exkl. Schrauben)
	102892	14	5	10	-	●	●		●	●			6 Stk. Spanneinsätze (inkl. 2 Stk. 102609 Schrauben)
	102813												8 Stk. Spanneinsätze (inkl. 2 Stk. 102609 Schrauben)
	102593												10 Stk. Spanneinsätze (exkl. Schrauben)
 Spanneinsatz-fg flach geriffelt Insert de serrage-fg à rainurage plat clamping insert-fg flat corrugation	102594												1 Stk. Spanneinsatz (exkl. Schrauben)
	102893	14	5	10	-	●	●		●	●			6 Stk. Spanneinsätze (inkl. 2 Stk. 102609 Schrauben)
	102814												8 Stk. Spanneinsätze (inkl. 2 Stk. 102609 Schrauben)
	102595												10 Stk. Spanneinsätze (exkl. Schrauben)
 Spanneinsatz-fh flach, Hartmetall beschichtet Insert de serrage-fh plane, peinte de métal dur clamping insert-fh flat, hard metal coated	102596												1 Stk. Spanneinsatz (exkl. Schrauben)
	102894	14	5	10	-	●	●		●	●			6 Stk. Spanneinsätze (inkl. 2 Stk. 102609 Schrauben)
	102815												8 Stk. Spanneinsätze (inkl. 2 Stk. 102609 Schrauben)
	102597												10 Stk. Spanneinsätze (exkl. Schrauben)
 Spanneinsatz-fl flach Insert de serrage-fl plane clamping insert-fl flat	102598												1 Stk. Spanneinsatz (exkl. Schrauben)
	102895	14	5	10	-	●	●		●	●			6 Stk. Spanneinsätze (inkl. 2 Stk. 102609 Schrauben)
	102816												8 Stk. Spanneinsätze (inkl. 2 Stk. 102609 Schrauben)
	102599												10 Stk. Spanneinsätze (exkl. Schrauben)
 Spanneinsatz-ps für Prägesysteme Insert de serrage-ps pur le système de gaufrage clamping insert-ps for pres clamping system	102600												1 Stk. Spanneinsatz (exkl. Schrauben)
	102896	14	5	10	-	●	●		●	●			6 Stk. Spanneinsätze (inkl. 2 Stk. 102609 Schrauben)
	102817												8 Stk. Spanneinsätze (inkl. 2 Stk. 102609 Schrauben)
	102601												10 Stk. Spanneinsätze (exkl. Schrauben)
 Abdeckung für Spanneinsatztaschen Couverture pour les poches d'insertion de serrage Cover for clamping insert pockets	102602												1 Stk. Abdeckung (exkl. Schrauben)
	102897	14	4	10	-	●	●		●	●			6 Stk. Abdeckungen (inkl. 2 Stk. 102609 Schrauben)
	102818												8 Stk. Abdeckungen (inkl. 2 Stk. 102609 Schrauben)
	102603												10 Stk. Abdeckungen (exkl. Schrauben)
 Schraube für Spanneinsätze und Werkstückauflagen varia Produktfa- milie, TX15 Antrieb Vis pour inserts de serrage et supports de pièce famille de produits varia, entraînement TX15 Screw for clamping inserts and workpiece supports varia product family, TX15 drive	102609	-	7.2	-	M 3.5								1 Stk. Schraube
	102610	-	7.2	-	M 3.5								10 Stk. Schrauben
 Fähnchenschlüssel TX15 passend zur Schraube 102609 Clé en drapeau TX15 compatible avec la vis 102609 Flag wrench TX15 suitable for screw 102609	102619	-	-	-	-								1 Stk. Fähnchenschlüssel

Grund- und Aufsatzbacken varia Produktfamilie | mors de base et mors rapportés famille de produits varia | base jaws and top jaws varia product family

	Bezeichnung Description Description	Artikelnr. Numéro d'article Article No.		Passend zu compatible avec compatible with		Lieferumfang Éléments livrés Scope of Delivery
				varia Polytec	varia G inverse	
	Aufsatzbacke Z 78WS	Paar paire pair 102878				Paar: 2 Stk. Aufsatzbacken B = 78mm für 4 Spanneinsätze pro Backenseite
	Mors rapporté Z 78WS Top jaw Z 78WS	Einzelteil pièce unique single part 102879		●	●	Paire : 2 mors rapportés B = 78mm pour inserts de serrage Pair: 2 top jaws B = 78mm for clamping inserts
	Aufsatzbacke Z 114WS	Paar paire pair 102872				Paar: 2 Stk. Aufsatzbacken B = 114mm für 6 Spanneinsätze pro Backenseite
	Mors rapporté Z 114WS Top jaw Z 114WS	Einzelteil pièce unique single part 102873		●	●	Paire : 2 mors rapportés B = 114mm pour inserts de serrage Pair: 2 top jaws B = 114mm for clamping inserts
	Aufsatzbacke Z 114WY1	Paar paire pair 102905				Paar: 2 Stk. Aufsatzbacken B = 114mm, flach geschliffen mit Stufen auf der Innen- und Ausenseite
	Mors rapporté Z 114WY1 Top jaw Z 114WY1	Einzelteil pièce unique single part 102906		●	●	Paire : 2 mors rapportés B = 114mm, rectifiés à plat avec des étapes sur les faces intérieure et extérieure Pair: 2 top jaws B = 114mm, flat ground with steps on the inside and outside
	Aufsatzbacke Z 114WB	Paar paire pair 102876				Paar: 2 Stk. Aufsatzbacken B = 114mm für Formbacken
	Mors rapporté Z 114WB Top jaw Z 114WB	Einzelteil pièce unique single part 102877		●	●	Paire : 2 mors rapportés B = 114mm pour mors profilés Pair: 2 top jaws B = 114mm for form jaws

Zubehör varia Produktfamilie | Accessoires famille de produits varia

Accessories varia product family

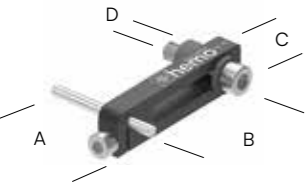
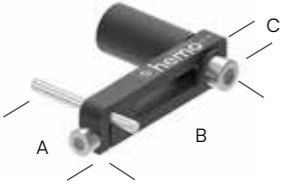
Bezeichnung Description Description	Artikelnr. Numéro d'article Article No.	Masse (mm) Dimensions (mm) Dimensions (mm)				Passend zu Backen compatible avec compatible with						Lieferumfang Eléments livrés Scope of Delivery		
		A	B	C	D	varia Plus			varia Polytec und G inverse					
						Z42S	Z78S	Z78B	Z 78WS	Z 114WS	Z 114WB			
 <p>Werkstückauflage 78S-M mit vier Taschen für Spanneinsätze <i>Support de pièce 78S-M</i> vec quatre poches pour inserts de serrage <i>Workpiece support 78S-M</i> with four pockets for clamping inserts</p>	102604	-	-	-	-									<p>1 Stk. Werkstückauflage (exkl. Schraube) <i>1 pièce de support de pièce (hors vis)</i> <i>1 piece of workpiece support (excluding screw)</i></p>
 <p>Werkstückauflage 114S-M mit sechs Taschen für Spanneinsätze <i>Support de pièce 114S-M</i> vec six poches pour inserts de serrage <i>Workpiece support 114S-M</i> with six pockets for clamping inserts</p>	102875	-	-	-	-									<p>1 Stk. Werkstückauflage (exkl. Schraube) <i>1 pièce de support de pièce (hors vis)</i> <i>1 piece of workpiece support (excluding screw)</i></p>
 <p>Seitenanschlag geschraubt <i>butée latérale vissée</i> <i>side stop screwed</i></p>	100884	40	60	15	M6									<p>1 Stk. inkl. Schraube und Distanzstück <i>1 pièce avec vis de fixation et entretoise</i> <i>1 piece including fastening screw and spacer</i></p>
 <p>Seitenanschlag magnetisch <i>butée latérale magnétique</i> <i>side stop magnetic</i></p>	100198	70	70	20	-									<p>1 Stk. inkl. Schraube und magnetischem Distanzstück <i>1 pièce avec vis de fixation et entretoise magnétique</i> <i>1 piece including fastening screw and magnetic spacer</i></p>

Zubehör varia Produktfamilie | Accessoires famille de produits varia | Accessories varia product family

Bezeichnung Description Description	Artikelnr. Numéro d'article Article No.		Passend zu Grundplattengrößen compatible avec compatible with			Lieferumfang Éléments livrés Scope of Delivery
			varia Polytec		varia G inverse	
			320-G	520-G	alle Größen	
 <p>Handrad Torx T60 auf 1/2" Länge 100mm Volant Torx T60 à 1/2" handwheel Torx T60 to 1/2"</p>	102880		•	•		<p>1 Stk. Handrad 1 pièce de volant 1 piece of handwheel</p>
 <p>Handrad Torx T60 auf 1/2" Länge 200mm Volant Torx T60 à 1/2" handwheel Torx T60 to 1/2"</p>	104069			•		<p>1 Stk. Handrad 1 pièce de volant 1 piece of handwheel</p>
 <p>Hebevorrichtung zum Anheben mittels Kran oder Kettenzug Dispositif de levage pour élévation par grue ou palan Lifting device for lifting by crane or chain hoist</p>	104116		•	•	•	<p>1 Stk. Hebevorrichtung inkl. Ringschraube 1 pièce de dispositif de levage avec œillet 1 piece lifting device including eye bolt</p>

VARIA G INVERSE

Der niedrige Allrounder

Ideal für tägliche Aufgaben im 3- und 5-Achsbereich. Die kompakte Bauweise bietet Flexibilität und Präzision in engen Arbeitsräumen und gewährleistet zuverlässige Leistung.

Le modèle bas polyvalent

Idéal pour les tâches quotidiennes en applications 3 et 5 axes. Sa conception compacte offre flexibilité et précision dans les espaces réduits tout en garantissant des performances fiables.

The low-level allrounder

Ideal for daily tasks in 3- and 5-axis applications. The compact design provides flexibility and precision in tight spaces while ensuring reliable performance.

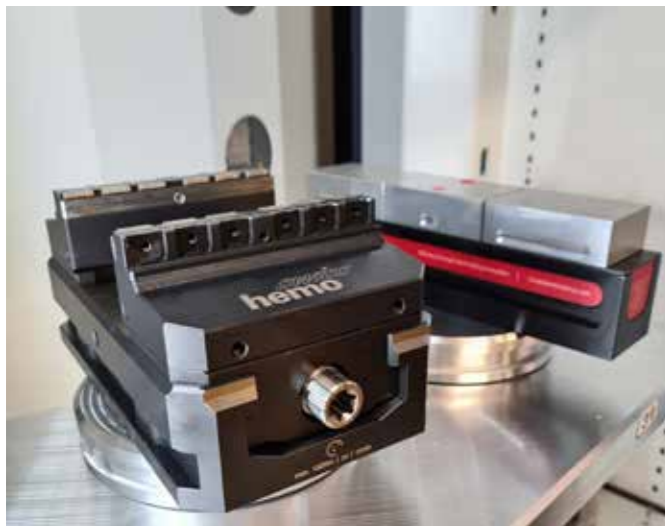

SCAN
ME



Stehen Sie vor weiteren Herausforderungen in Ihrer täglichen Arbeit?

Wir bieten eine breite Palette an Spannmitteln und unterstützen Sie gerne mit der passenden Lösung. Besuchen Sie uns eine Mail auf info@hemo.ch oder rufen Sie uns an unter +41 (0) 41 348 04 04. Wir sind bereit für Ihre Herausforderungen!





Faites-vous face à de nouveaux défis dans votre travail quotidien ?

Nous proposons une large gamme de solutions de serrage et vous accompagnons avec la solution adaptée. Envoyez-nous un e-mail à info@hemo.ch ou appelez-nous au +41 (0) 41 348 04 04. Nous sommes prêts à relever vos défis!

Are you facing further challenges in your daily work?

We offer a wide range of clamping solutions and are happy to support you with the right solution. Send us an email at info@hemo.ch or call us at +41 (0) 41 348 04 04. We are ready for your challenges!

			
varia Mini Unsere Mini-Lösung für Ihre grossen Probleme Der kleine überzeugt durch 12kN Spannkraft und der gewohnten hemo Präzision von ≤ 0.01 mm Notre solution mini pour vos grands problèmes Ce petit dispositif convainc par une force de serrage de 12 kN et la précision habituelle de hemo de $\leq 0,01$ mm. Our mini solution for your big problems The small one impresses with 12 kN clamping force and the usual hemo precision of ≤ 0.01 mm.	varia Plus Willkommen in der Welt der Varianten Mit dem varia Plus haben wir die erfolgreiche varia Produktfamilie gestartet. Mehr Spannkraft, Zugänglichkeit, Präzision und Modularität für beste Ergebnisse. Bienvenue dans le monde des variantes Avec le varia Plus, nous avons lancé la famille de produits varia. Plus de force de serrage, d'accessibilité, de précision et de modularité pour des résultats optimaux. Welcome to the world of variants With varia Plus, we launched the successful varia product family. More clamping force, accessibility, precision, and modularity for optimal results.	varia Polytec Mit einem Klick von klein zu gross Mit einem Klick von klein zu gross. Die patentierte hemo Backenschnellverstellung erlaubt ein Umrüsten von minimaler zu maximaler Spannweite in Sekunden Système de réglage rapide des mors en un clic D'un clic, passez de petit à grand. Le système de réglage rapide des mors breveté de hemo permet de passer en quelques secondes de la plage de serrage minimale à la plage maximale. Quick jaw-adjustment unit with one click With a click from small to large. The patented hemo quick-jaw adjustment system allows switching from minimal to maximal clamping range in seconds.	varia G inverse Der niedrige Allrounder Ideal für tägliche Aufgaben im 3- und 5-Achsbereich. Die kompakte Bauweise bietet Flexibilität und Präzision in engen Arbeitsräumen und gewährleistet zuverlässige Leistung. Le modèle bas polyvalent Idéal pour les tâches quotidiennes en applications 3 et 5 axes. Sa conception compacte offre flexibilité et précision dans les espaces réduits tout en garantissant des performances fiables. The low-level allrounder Ideal for daily tasks in 3- and 5-axis applications. The compact design provides flexibility and precision in tight spaces while ensuring reliable performance.

			
optima II Das kleine Kraftpaket Für die erste und zweite Aufspannung. Mit einer Spannkraft von 30 kN und einer Wiederholgenauigkeit von 0.01 mm. Le petit paquet de force Pour le premier et le deuxième serrage. Avec une force de serrage de 30 kN et une répétabilité de 0.01 mm. The small power pack For the first and second clamping processes, with a clamping power of 30 kN and a repeatability, precision and modularity for the best production results.	optima Der Preiswerte Bestens geeignet für Ihre Ansprüche in der ersten und zweiten Aufspannung bei einer Wiederholgenauigkeit von 0.01 mm. Le moins cher Parfaitement adapté aux exigences d'un premier et second serrage pour une épétabilité de 0.01 mm. The best value Perfectly meets your requirements, repeat accuracy of 0.01 mm in the first and second clamping assembly.	basic Der Allrounder Bestens geeignet für Ihre Ansprüche in der ersten und zweiten Aufspannung bei einer Wiederholgenauigkeit von 0.005mm. Le polyvalent Parfaitement adapté aux exigences d'un premier et second serrage pour une répétabilité de 0.005mm. The All-rounder Perfectly meets your requirements, repeat accuracy of 0.005 mm in the first and second clamping assembly.	hi-tec Das Kraftpaket Kombiniert die Bedürfnisse bei der CNC-5-Achsen-Bearbeitung: eine Wiederholgenauigkeit von 0.003 mm und eine Spannkraft von 57 kN. Le puissant Combine les besoins pour un usinage à 5 axes sur commande numérique: une répétabilité de 0.003 mm et une force de serrage de 57 kN. The power horse Meets all the combined needs of CNC 5-axis machining: a repeat accuracy of 0.003 mm and a clamping force of 57 kN.

Hersteller:

hemo AG

Dattenmattstrasse 12

CH-6010 Kriens

Telefon +41 (0) 41 348 04 04

info@hemo.ch

Folgen Sie uns auf



Vertrieb:

